

**STEERING DIODE (RAIL CLAMP) ARRAY**
**APPLICATIONS**

- High Frequency Data Lines
- RS-232 & RS-422 Interface Networks
- 10 Base T Networks
- LAN/ WAN
- Computer I/O Ports

**FEATURES**

- IEC 1000-4-2, -4 & -5 Industry Requirements
- Designed for Rail Clamp Protection
- ESD Protection > 40 kilovolts
- Working Voltage > 50 Volts
- UL 94V-0 Flammability Classification
- Available in Standard SO-14 Surface Mount Package

**DESCRIPTION**

This series is designed with discrete diodes for complete isolation. Each diode can be individually tested according to the electrical characteristics. For transient voltage protection, two diodes are configured in series with the anode of one connect to the cathode of the other diode (See Rail Clamp Circuit).

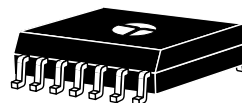
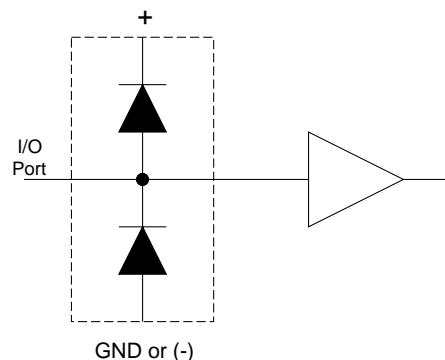
**IEC 1000-4 COMPATIBLE**

**SO-14 PACKAGE**
**RAIL CLAMP CIRCUIT**

SEE DIAGRAMS ON FOLLOWING PAGE.

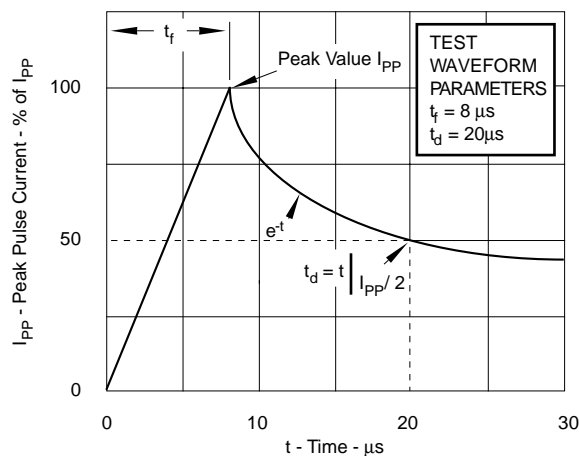
<b>MAXIMUM RATINGS @ 25°C Ambient Temperature</b> (unless specified)	
Continuous Power Dissipation	500mW
Operating & Storage Temperature	-65° to +150°C
Continuous Forward Current	400mA
<b>MECHANICAL CHARACTERISTICS</b>	
Package	Molded SO-14 Surface Mount Package
Packaging	Tube or 16mm Tape per EIA 481
Approximate Weight	0.15 grams
Device Markings	Logo & Part Number
Miscellaneous	Pin No. 1 Indicated by Dot on Top of Package

**FIGURE 1  
PULSE WAVE FORM**

# ELECTRICAL CHARACTERISTICS @ 25° C Ambient Temperature

PROTEK PART NUMBER	REPETITIVE PEAK REVERSE VOLTAGE @ 10 $\mu$ A $V_{PRP \text{ Min}}$ VOLTS	REVERSE LEAKAGE CURRENT @ 40 V $I_{RM}$ $\mu$ A	MAXIMUM FORWARD VOLTAGE @ 100 mA $V_F$ VOLTS	FORWARD PEAK PULSE CURRENT (See Fig. 1) @ 8/20 $\mu$ s $I_{PP}$ AMPS	MAXIMUM CAPACITANCE @ 4 V, 1 MHz C pF
See Note 1	50	0.1	1.2	40	25

**Note 1:** Device Types Include: PMMAD130, PMMAD1103, PMMAD1105, PMMAD1106, PMMAD1107 and PMMAD1109. Electrical characteristics applies to all device types.

## CIRCUIT DIAGRAM

**PMMAD130**

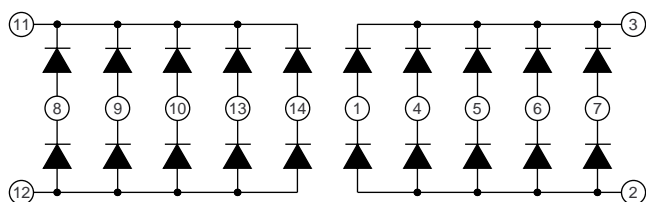

**DUAL 10 DIODE ARRAY**

**PMMAD1106**

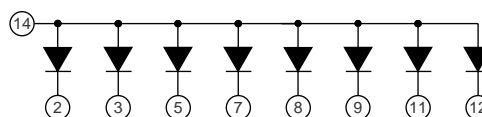

**8 DIODE COMMON ANODE ARRAY**  
NC Pin 1, 4, 6, 10 & 13

**PMMAD1103**

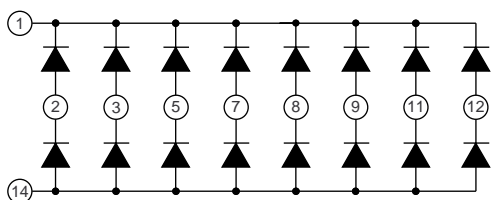

**16 DIODE ARRAY**  
NC Pins 4, 6, 10 & 13

**PMMAD1107**

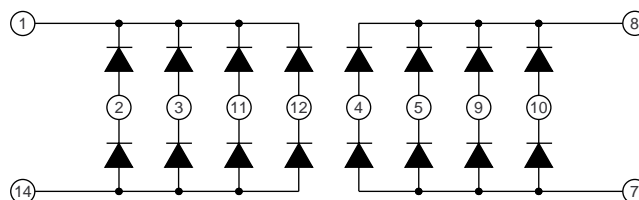

**DUAL 8 DIODE ARRAY**  
NC Pins 6 & 13

**PMMAD1105**

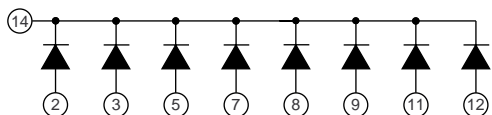

**8 DIODE COMMON CATHODE ARRAY**  
NC Pins 1, 4, 6, 10 & 13

**PMMAD1109**

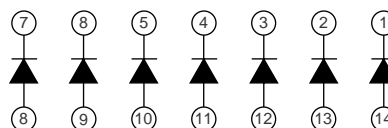

**7 ISOLATED DIODE ARRAY**  
(Independent)



**STEERING DIODE (RAIL CLAMP) ARRAY**

ELECTRICAL CHARACTERISTICS @ 25° C Ambient Temperature					
PROTEK PART NUMBER	REPETITIVE PEAK REVERSE VOLTAGE @ 10 $\mu$ A $V_{PRP \text{ Min}}$ VOLTS	REVERSE LEAKAGE CURRENT @ 40 V $I_{RM}$ $\mu$ A	FORWARD PEAK PULSE CURRENT (See Fig. 1) @ 8/20 $\mu$ s $I_{PP}$ AMPS	MAXIMUM FORWARD VOLTAGE @ 100 mA $V_F$ VOLTS	MAXIMUM CAPACITANCE @ 4 V, 1 MHz C pF
PMMAD1108	50	0.1	40	1.2	25

**APPLICATIONS**

- High Frequency Data Lines
- RS-232 & RS-422 Interface Networks
- 10 Base T Networks
- LAN/ WAN
- Computer I/O Ports

**FEATURES**

- IEC 1000-4-2, -4 & -5 Industry Requirements
- Eight (8) Individual Steering Diodes
- Designed for Rail Clamp Protection
- ESD Protection > 40 kilovolts
- Working Voltage > 50 Volts
- UL 94V-0 Flammability Classification
- Available in Standard SO-14 Surface Mount Package

**DESCRIPTION**

This device is designed with discrete diodes for complete isolation. Each diode can be individually tested according to the electrical characteristics. For transient voltage protection, two diodes are configured in series with the anode of one connect to the cathode of the other diode (See Rail Clamp Circuit).

MAXIMUM RATINGS	
Continuous Power Dissipation	500mW
Operating & Storage Temperature	-65° to +150°C
Continuous Forward Current	400mA
MECHANICAL CHARACTERISTICS	
Package	Molded SO-16 Surface Mount Package
Packaging	Tube or 16mm Tape per EIA 481
Approximate Weight	0.15 grams
Device Markings	Logo & Part Number
Miscellaneous	Pin No. 1 Indicated by Dot on Top of Package

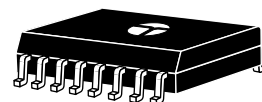
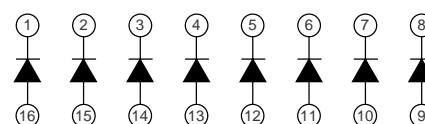
**IEC 1000-4 COMPATIBLE**

**SO-16 PACKAGE**
**CIRCUIT DIAGRAM**

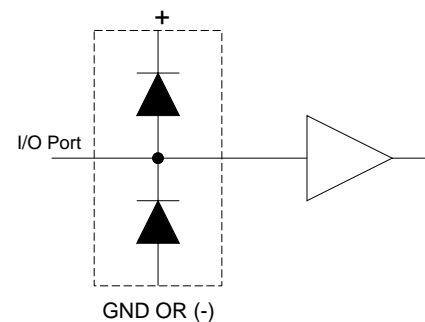
**PMMAD1108**  
8 ISOLATED DIODE ARRAY

**RAIL CLAMP CIRCUIT**

**FIGURE 1**  
PULSE WAVE FORM

